

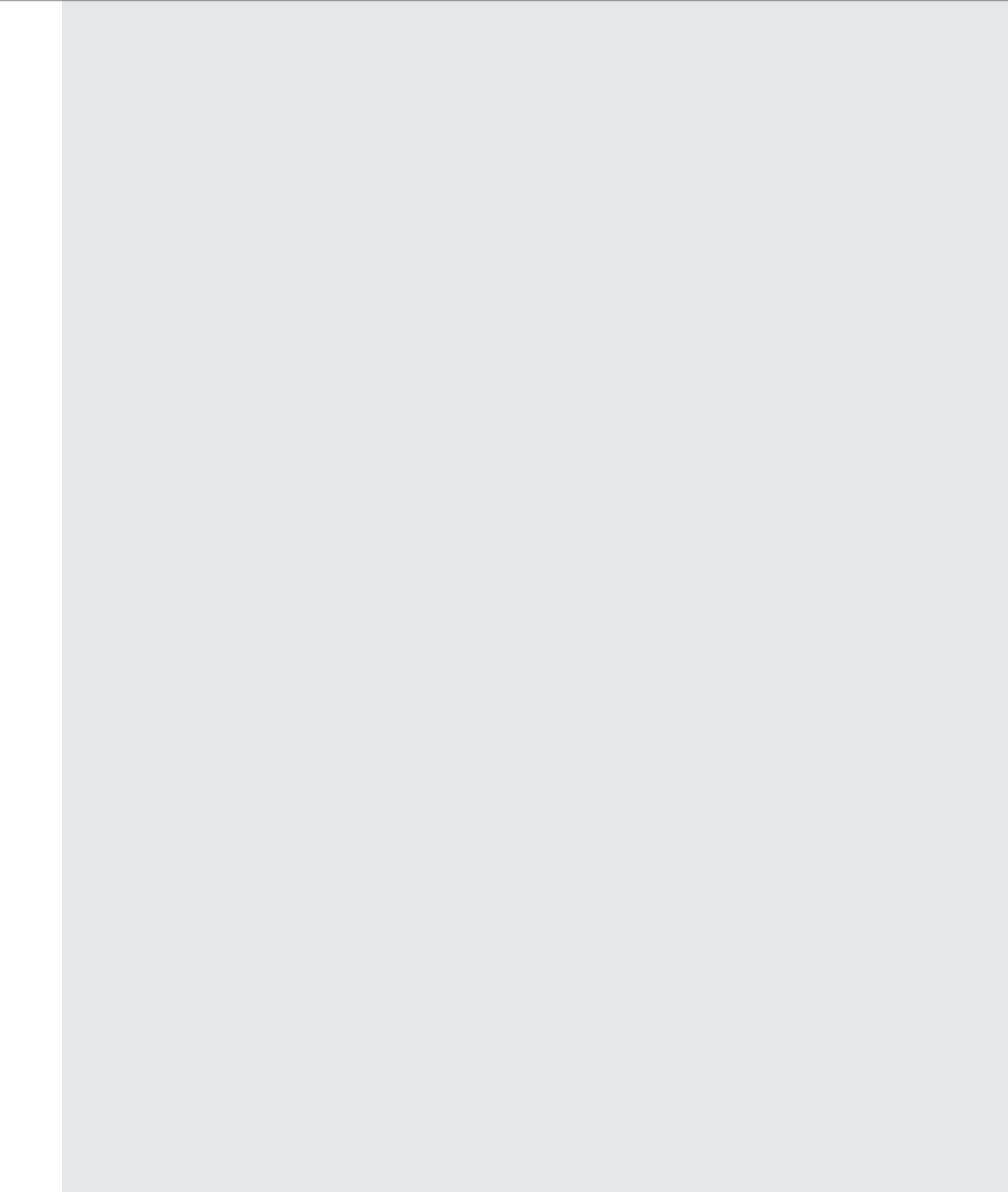



**FLUX 0**  
**DIGITAL FLOWMETER AND PRESSURE SENSOR**  
**USER MANUAL**





# Product Safety Instructions

■ This section indicate the levels of risks with the labels of Danger, Warning and Caution.

 <b>Danger</b>	Danger indicates high level of risk, will lead to fatal or serious injuries if not avoided.
 <b>Warning</b>	Warning indicates medium level of risk, it might cause death or serious injuries.
 <b>Caution</b>	Caution indicates low level of risk, it might result in minor injuries, such as scald, electric shock, etc. and the product, equipment and machines might be damaged.

## Warning

### ■ Precautions for use

- ① **Operated within the specified voltage.**  
Malfunction or damaged product, electric shock or fire may be resulted by exceeding the specified voltage range.
- ② **Do not exceed the maximum load current.**  
It may damage the product.
- ③ **Do not use any load that generates surges.**  
Surge protection is present but applying surge voltage repeatedly will ultimately damage the product.  
When using with inductive load (such as relay or solenoid), please install a flyback diode across the load (polarity must be observed).
- ④ **Observed the internal voltage drop.**  
When used at a specified voltage, if the sensor is functional but the load does not work, please check if the operating voltage of the load meets the following formula.
 

$$\text{Power Supply} - \text{Internal voltage} > \text{Minimum operating voltage} \quad \text{drop of sensor} \quad \text{voltage of load}$$
- ⑤ **Do not operate the product outside the specifications.**  
The sensor will be damaged by exceeding the flow rate and working pressure.
- ⑥ **Do not use flammable fluids and/or permeable fluids.**  
They may cause fire, explosion or corrosion.

### ■ Working fluid and working environment

- ① **Do not use in an explosive gas atmosphere.**  
The sensor does not have explosion-proof structure, fire, explosion or corrosion can result.
- ② **Do not use near a surge voltage generated area.**  
Solenoid lifters, high frequency induction furnaces and motors, etc. can generate high surge voltages, if using near the sensor will cause the internal circuit components to deteriorate and cause damages.
- ③ **Sensors can not withstand lightning strikes.**  
The product is CE compliant, but can not resist surge voltage of lightning strikes, take measures to avoid lightening strikes in the system.
- ④ **Do not use in an environment where sensors could be splashed by water or oil.**  
Enclosure rating is IP40, please avoid water or oil splashed environment to prevent adversely effects.
- ⑤ **Do not use in an environment subject to large temperature cycling.**  
Internal components of the sensor will be affected adversely by large heating/cooling cycles other than ordinary changes in temperature.
- ⑥ **Do not mount the product in locations where it is exposed to radiant heat.**  
This could result in damage and/or malfunction.

## Warning

### ■ Wiring Precautions

- ① **Check wire color and terminal number when wiring.**  
Incorrect wiring can cause permanent damages to the sensor, check wire color and terminal number against the manual before wiring.
- ② **Avoid repeatedly bending or stretching the lead wire.**  
It can cause damage to the sheath, or breakage of the wire.
- ③ **Confirm wiring insulation**  
Please avoid poor insulations (and interference from another circuit, poor insulation between terminals, etc.) it can lead to over current being applied to the product, causing damage.
- ④ **Do not route wires and cables together with power or high voltage cables.**  
The product may malfunction due to interference or noise and surge voltage from power and high voltage cables.
- ⑤ **Do not short-circuit the load.**  
When the load is short-circuited, an error will be displayed. But excess current may cause damage to the sensor.
- ⑥ **Do not connect wire when the power is on.**  
It may cause damages to the sensors/equipment/machines.

### ■ Installation Precautions

- ① **Ensure the flow direction of the fluid.**  
Please follow the flow direction indicator for installation and piping.
- ② **Flush out all dirt and dust by air blow before connect the piping to the sensor.**
- ③ **Do not drop or hit.**  
When installation, do not drop, hit or apply excessive shock (100m/s<sup>2</sup>). Internal damage can cause malfunction even if the housing appears to be undamaged.
- ④ **Do not install multiple products in close proximity.**  
The heat generated from each product could cause the temperature to rise and change the characteristics of product or deterioration of the plastic parts. Please set the products 10mm apart from each other.
- ⑤ **Hold the sensor body when installing.**  
The tensile strength of the cable is 24.5 N and apply excessive pulling force can cause damage to the sensor.

### ■ Other Precautions

- ① **After power is supplied, the output will remain off until the display is turned on. Please operate the sensor after the value is shown.**
- ② **Stop the control systems before perform setting changes.**  
During the initial flow and pressure setting, the product will switch the output according to the existing settings until the changes are complete.

## Caution

### ■ Installation Precautions

- ① **Please follow the specified tightening torque.**  
Over tighten will damage the product.
- ② **Do not mount the sensor in a place that will be used as a foothold.**  
The product may damage if sit or step on it accidentally.
- ③ **When mounting without a bracket, please use P type self-tapping screw- M3 x L 6mm.**
- ④ **Do not remove the fixed pin for the One-Touch Fitting.**  
To avoid losing the internal parts and cause malfunction.

### ■ Maintenance Precautions

- ① **The accuracy could change by 2 to 3% when the piping is removed or replaced.**
- ② **Do not insert a stick or wire into the piping ports.**
- ③ **Do not touch the terminals or connectors when power is on.**

## ⚠ Warning

### ■ Fluid

- ① **Check the regulator and flow adjustment valve before introducing the fluid.**  
If the pressure or flow rate exceeded the specified range, the sensing element may be damaged.
- ② **The sensing element cannot measure properly if foreign matter adheres to it.**
- ③ **On the inlet side, be sure to install an air filter below the filtration level of 10um.**

### ④ Recommended Equipments and Installation

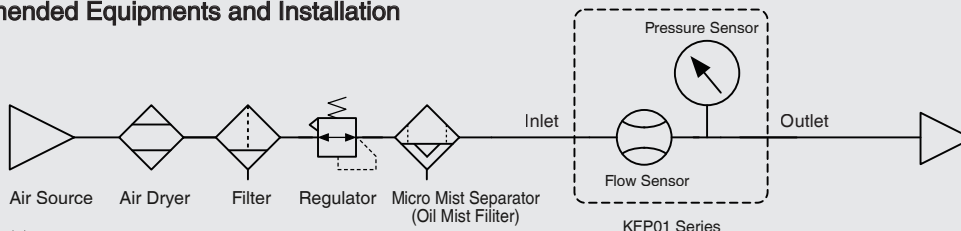

**※ NOTE :**

When measuring the pressure of the inlet side, install a throttle valve or solenoid valve on the outlet side.  
When measuring the pressure of the outlet side, install a throttle valve or solenoid valve on the inlet side.

### ⑤ Recommended Equipments and Installation Example

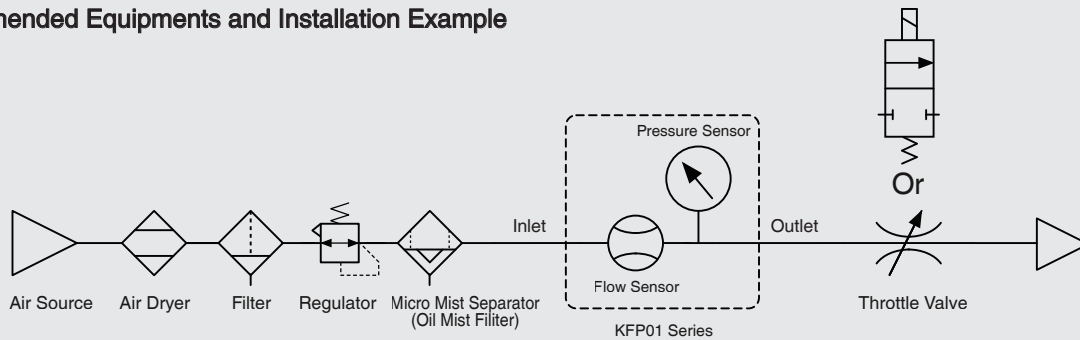

**※ NOTE :** When measuring the pressure of the inlet side, install a throttle valve or solenoid valve on the outlet side.

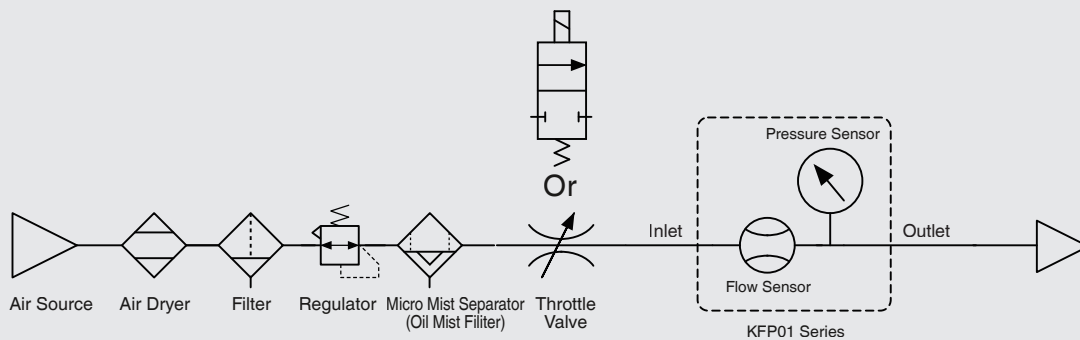

**※ NOTE :** When measuring the pressure of the outlet side, install a throttle valve or solenoid valve on the inlet side.

## Disclaimer

- ① **Our warranty applies solely to our product, not to any other damages and injuries which occur by earthquakes, fires, the acts by third party, other matters, acts intentionally, acts accidentally, misuse, or other abnormal conditions that are not the responsible of KITA.**
- ② **Our warranty applies solely to our product, not to any other additional damages (the loses of business profits, business interruption, etc.) incurred due to using or misusing the product.**
- ③ **Our warranty excludes any injuries and damages happened by using the product beyond the specified range of catalog or/and not following the instruction manual.**

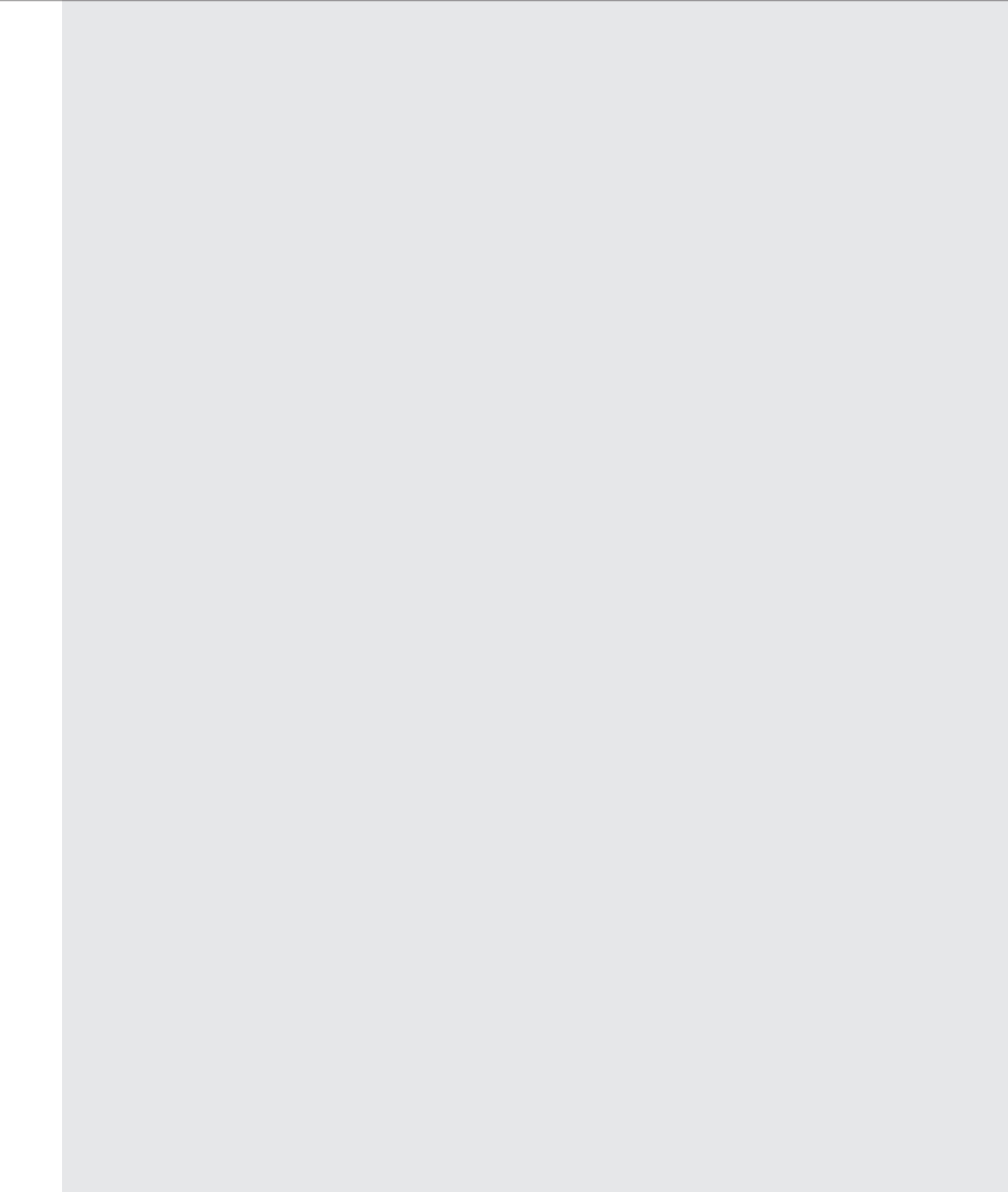

<b>1. INSTALLATION</b>	PAGE 8
1.1 PIPING	PAGE 8
1.2 MOUNTING BRACKET / OPTIONAL PARTS	PAGE 9
1.3 WIRING DIAGRAMS	PAGE 10
1.3.1 PNP Output, analog output and external input	PAGE 10
<b>2. HOW TO USE</b>	PAGE 11
2.1 NAMES AND FUNCTIONS OF INDIVIDUAL PARTS	PAGE 11
2.2 FUNCTION INSTRUCTION	PAGE 12
2.3 OPERATION INSTRUCTIONS	PAGE 13
2.3.1 [F-01] OUT1 Setting selection	PAGE 14
2.3.2 [F-02] OUT2 Setting selection	PAGE 19
2.3.3 [F-03] LCD Display color selection	PAGE 20
2.3.4 [F-04] Response time selection	PAGE 21
2.3.5 [F-05] Display refresh time selection	PAGE 23
2.3.6 [F-06] Unit selection	PAGE 25
2.3.7 [F-07] Flow reference standard selection	PAGE 26
2.3.8 [F-08] Analog output selection	PAGE 27
2.3.9 [F-09] Accumulated value hold selection	PAGE 28
2.3.10 [F-10] Flow sensor display mode selection	PAGE 29
2.3.11 [F-91] Power-save mode selection	PAGE 30
2.3.12 [F-92] External input selection	PAGE 31
2.3.13 [F-94] Fine adjustment setting	PAGE 32
2.3.14 [F-95] Forced output function	PAGE 34
2.3.15 [F-99] Reset to the default setting	PAGE 35
2.3.16 Pressure zero adjustment function	PAGE 36
2.3.17 Instantaneous flow zero adjustment function	PAGE 37
2.3.18 Reset accumulated flow function	PAGE 38
2.3.19 Peak value display	PAGE 39
2.3.20 Bottom value display	PAGE 40
2.3.21 Key lock / unlock mode	PAGE 41
<b>3. ERROR CODE INSTRUCTION</b>	PAGE 42
<b>4. TECHNICAL DATA</b>	PAGE 43
<b>5. THERMAL MASS FLOW SENSOR PRINCIPLES</b>	PAGE 44
<b>6. DIMENSIONS</b>	PAGE 45
<b>7. CONSTRUCTION</b>	PAGE 45



## 1. INSTALLATION

### 1.1 Piping

Install the pipe by following the arrow indication that shows the air flow direction on the product.

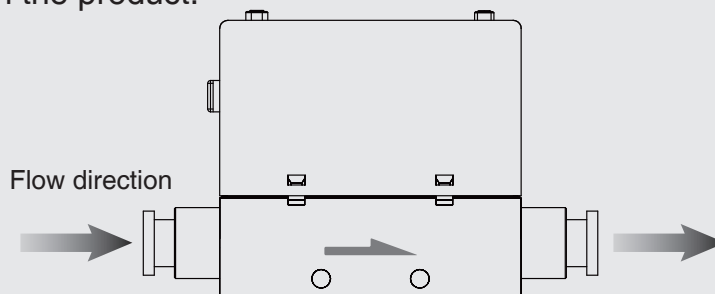

Use straight piping 8cm or longer to connect the Piping Port (Inlet side). If straight piping is not installed, the accuracy may vary by  $\pm 2\%$  F.S..

※ Straight Piping: The pipe is without bending and the cross sectional areas of the pipe keeps the same.

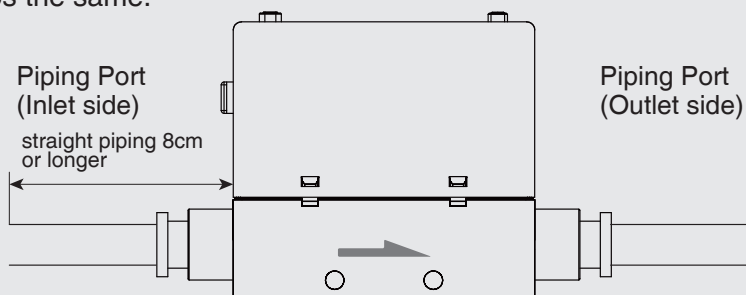

Blow the air to flush out the foreign matters, dust and etc. before installing the pipe. Uncleaned air may cause malfunction or damage to the product.

Piping for the One-Touch Fitting, insert the tube firmly into the fitting and make sure it cannot be pulled out. Also using the proper tube cutter is recommended to ensure square edge tube.

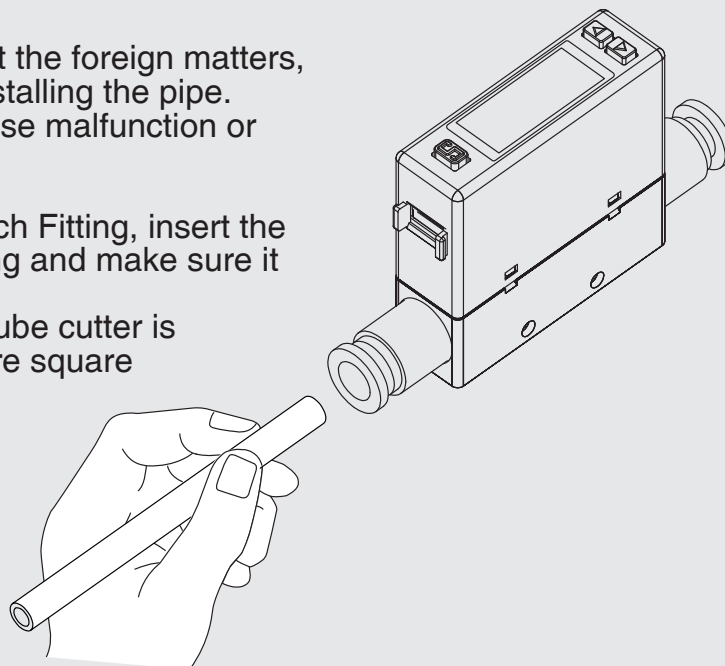



## 1.2 Mounting Bracket / Optional Parts

The LCD display may be difficult to see at certain angles.  
The sensor can be installed horizontally or vertically, but the flow rates may change because of the installation way of the product or piping.

The tightening torque for screws should be under  $0.5 \pm 0.1$  N.m.

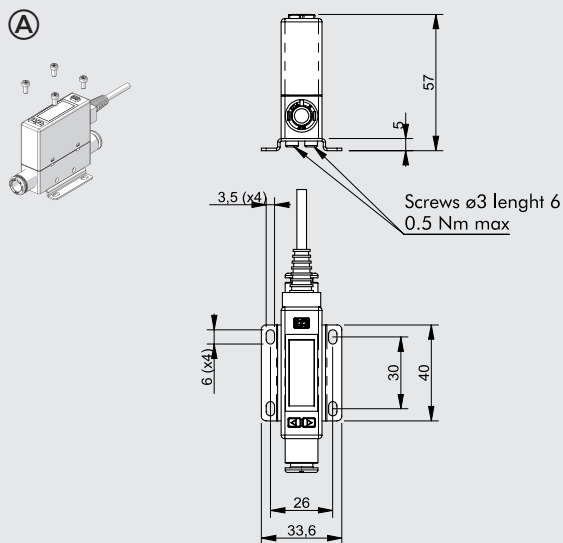

Fixing with bracket code 90009A001 using the included  $\varnothing 3$  self-tapping screws and M3 screws

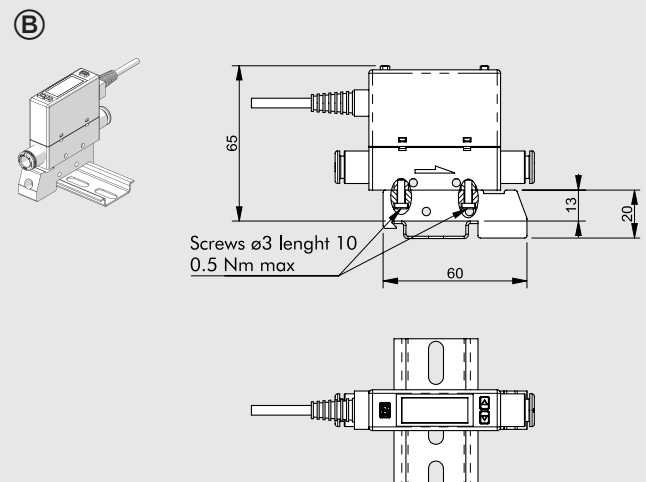

Single fixing on DIN bar with code bracket 90009A002 using the included  $\varnothing 3$  self-tapping screws

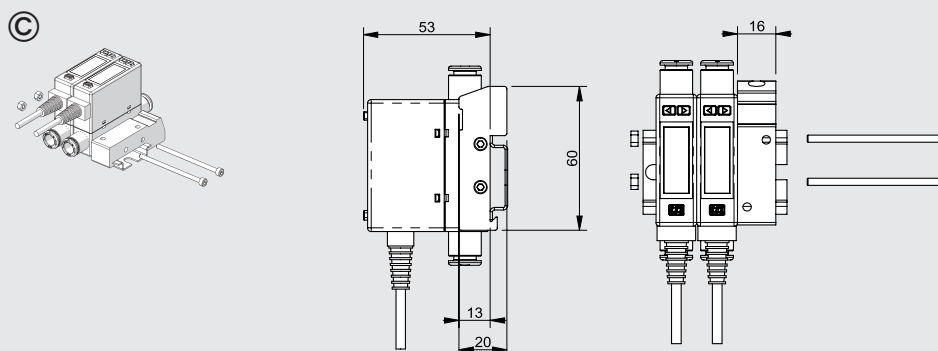

Multiple fixing on DIN bar with code bracket 90009A002 using the lateral holes  $\varnothing 3.4$  with M3 screws and nuts

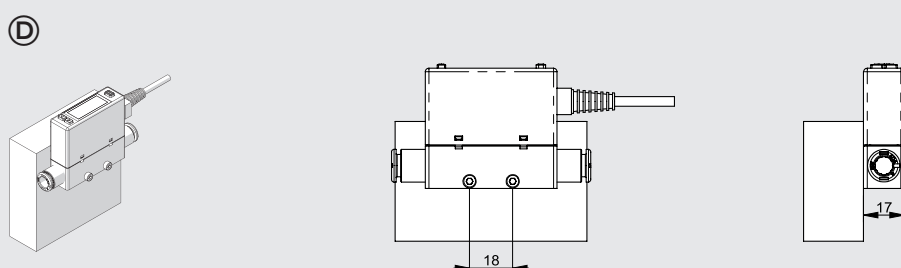

Side fixing using M3 screws, minimum length 23 mm

## 1.3 Wiring Diagrams

### 1.3.1 PNP Output, Analog Output and External Input

- PNP Output / Analog Voltage Output / External Input

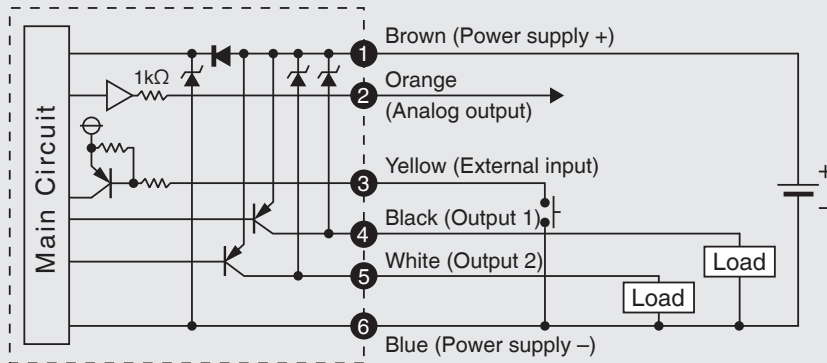

- PNP Output / Analog Current Output / External Input

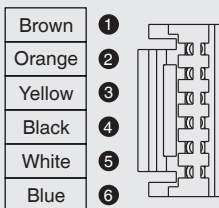
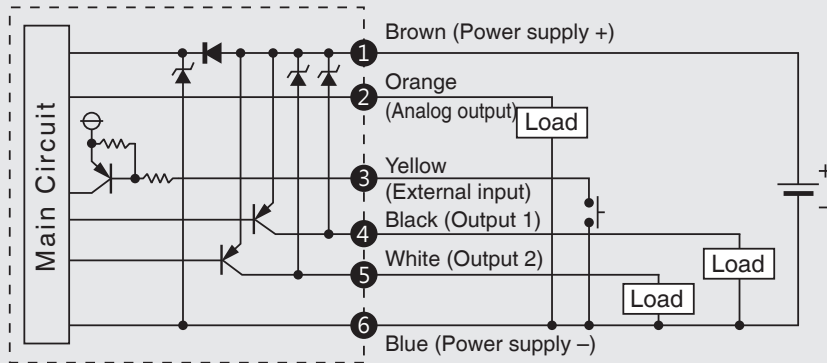

Pin No.	Line color	Content
1	Brown	Power supply (DC 12 to 24V DC)
2	Orange	Analog voltage output : 1 - 5V Analog current output : 4 - 20mA
3	Yellow	External input
4	Black	Output 1 (Max. load current : 125mA)
5	White	Output 2 (Max. load current : 125mA)
6	Blue	0V (GND)

## 2. HOW TO USE

### 2.1 Names and Functions of Individual Parts

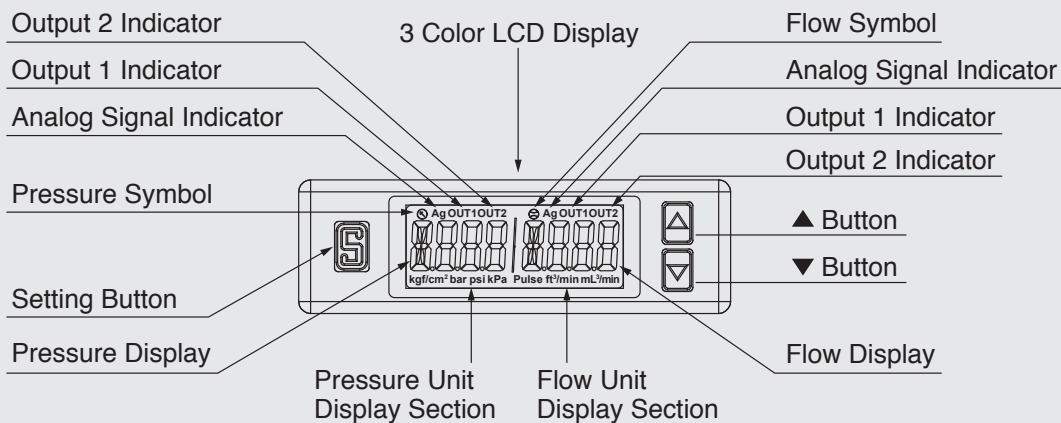
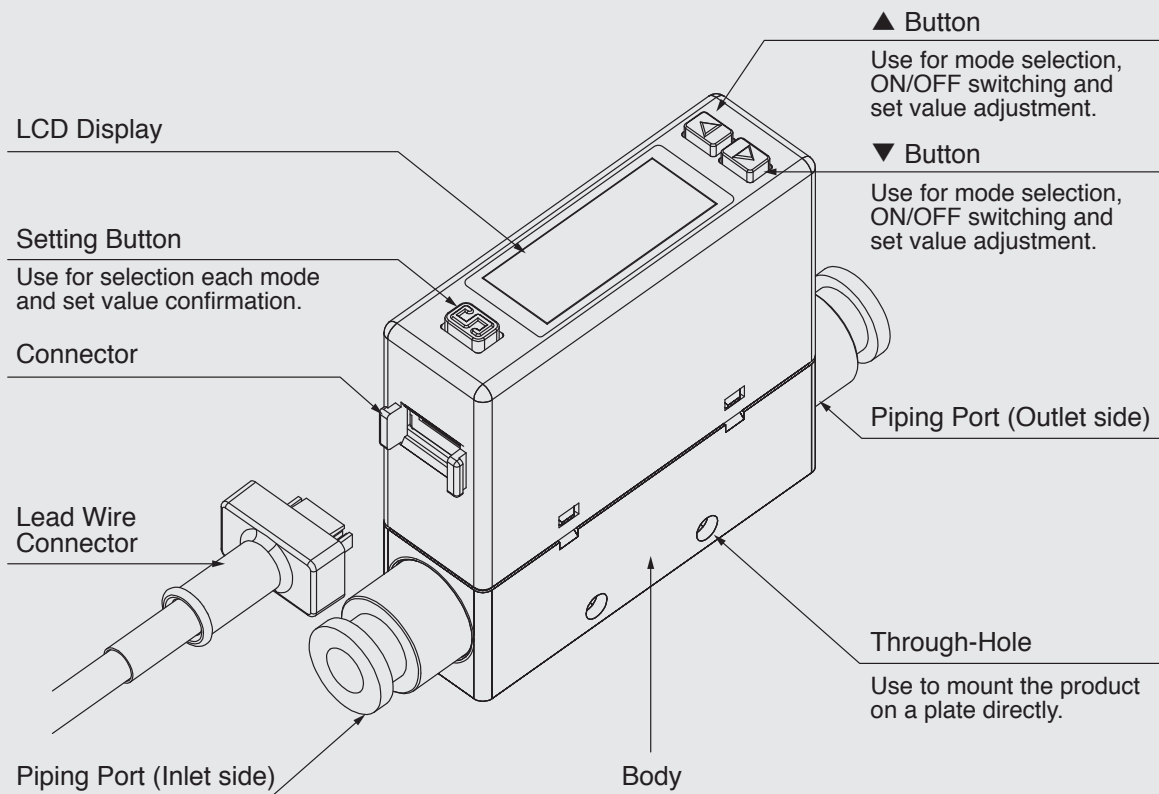

## 2.2 Function Instruction

### • Function Setting Mode



Function Code	Item	Explanation
[F-01]	[oUt1] OUT 1 setting	Select Output 1 corresponding to flow sensor or pressure sensor. Set the flow rate or pressure value to switch ON/OFF.
[F-02]	[oUt2] OUT 2 setting	Select Output 2 corresponding to flow sensor or pressure sensor. Set the flow rate or pressure value to switch ON/OFF.
[F-03]	[CLor] LCD Display color selection	Select back light color and display mode.
[F-04]	[rESP] Response time selection	Select the response time for analog output. Pressure sensor: 2.5ms ~ 1500ms. Flow sensor: 50ms ~ 1500ms.
[F-05]	[UPdA] Display refresh time selection	Display refresh cycle can be set in 200ms, 500ms or 1000ms.
[F-06]	[Unit ] Unit selection	Select the UNIT of pressure / flow sensor.
[F-07]	[rEFE] Flow reference standard selection	Select the flow value is shown under standard (ANR) or normal condition (NOR).
[F-08]	[ AnG] Analog output selection	Select the analog corresponding to pressure or flow sensor.
[F-09]	[EEPr] Accumulated value hold selection	To save the last accumulated flow value every 2 or 5 minutes.
[F-10]	[ diS ] Flow sensor display mode selection	Select to display Instantaneous Flow or Accumulated Flow Mode.
[F-91]	[ ECo] Power-Save mode selection	Select if turn on power-save mode to reduce power consumption
[F-92]	[ inP ] External input selection	Select for Accumulated flow rate zero clear, Auto-Shift or Auto-Shift zero.
[F-94]	[FinE] Fine adjustment Setting	The displayed value can be adjusted slightly.
[F-95]	[FoUt] Forced output function	To turn the analog ON/OFF forcibly.
[F-99]	[rESt ] Reset to the default setting	Return to the factory default setting.

### • Measurement Mode

Item	Explanation
Pressure display	Display pressure value.
Flow display	Display instantaneous flow rate.
Accumulated flow rate display	Display accumulated flow rate.
Pressure zero setting	The displayed pressure value can be adjusted to "0".
Instantaneous Flow rate zero setting	The displayed instantaneous flow rate value can be adjusted to "0".
Accumulated flow rate zero clear	The accumulated flow rate can be set to "0".
Peak value display	The maximum pressure or instantaneous flow can be detected when the power is supplied for a period.
Bottom value display	The minimum pressure or instantaneous flow can be detected when the power is supplied for a period.
Key lock/unlock mode	To prevent errors occurring due to unintentional changes of the set values.

## 2.3 Operation Instructions

### Function Selection Mode

At Measurement Mode, press  button for more than 3 sec. to display [F-01]. Press  or  button to select other setting functions.

Press  for 3 sec. at Function Setting Mode to return to Measurement Mode.

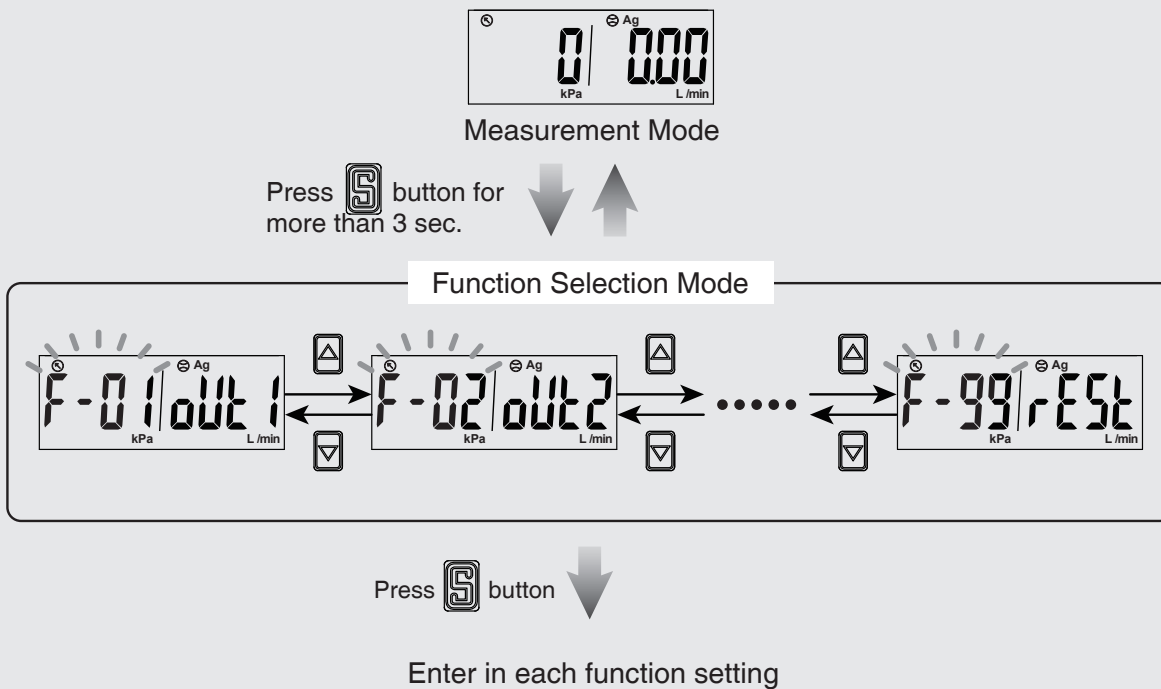

### 2.3.1 [F-□ ] OUT1 Setting Selection

Setting corresponding sensor and operating mode of OUT1.

- 1. Flow sensor setting

Press or button at Function Setting Mode to display [F-□ ] [OUT □].

Press button

#### Sensor Selection

Press or button to select flow sensor of OUT1.

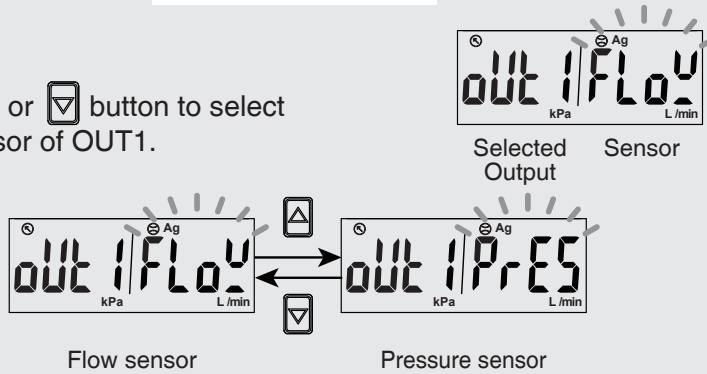

Press button

#### Output Mode Setting

Select output mode :

Press or button to select output mode of OUT1.

4 output modes included.

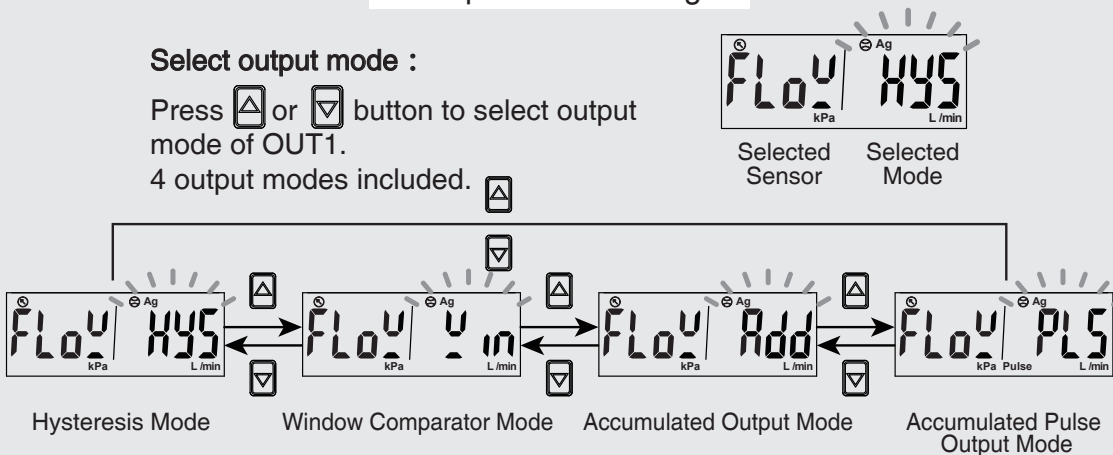



※ NOTE : The Accumulated Pulse Output Mode can only be set in OUT1, and OUT2 does not have this setting.

Press button (to be continued)

### Output Type Setting

#### OUT1 type setting :

Press  or  button to select OUT1 type.

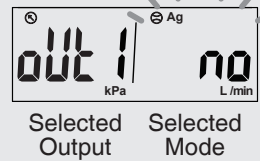
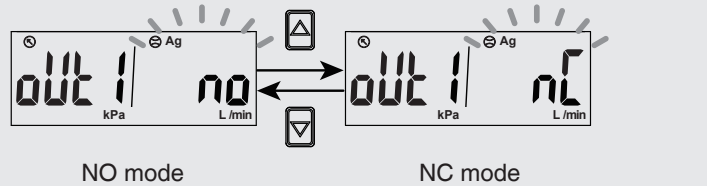



※NOTE : Type setting will not display when Accumulated Pulse Output Mode is set.

Press  button

### Set Value Setting

#### Out1 set value setting :

Press  or  button to adjust the set value.

Hysteresis Mode [HYS] : [FL - l] · [FH - l]

Window Comparator Mode [Win] : [FL - l] · [FH - l]

Accumulated Output Mode [Add] : [AddL] · [AddH]

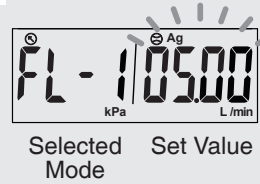



※NOTE : Set value setting will not display when Accumulated Pulse Output is set.

Press  button

### Fixed Hysteresis Setting

#### Fixed hysteresis setting :

Press  or  button to adjust fixed hysteresis value.

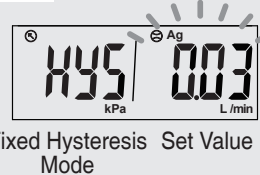

※NOTE : Fixed hysteresis setting will not display when Hysteresis Mode, Accumulated Output Mode and Accumulated Pulse Output Mode is set.

Press  button to return to Function Selection Mode



● 2. Pressure sensor setting

Press or button at Function Selection Mode to display [F-0 1] [OUT 1].

Press button ↓

Sensor Selection

Press or button to select pressure sensor of OUT1.

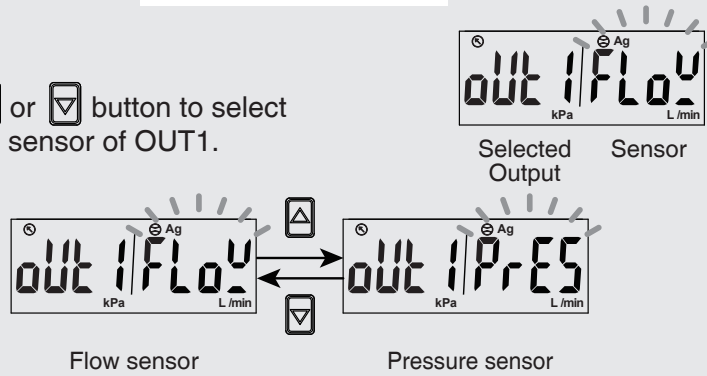

Press button ↓

Output Mode Setting

Select output mode :

Press or button to select output mode of OUT1.

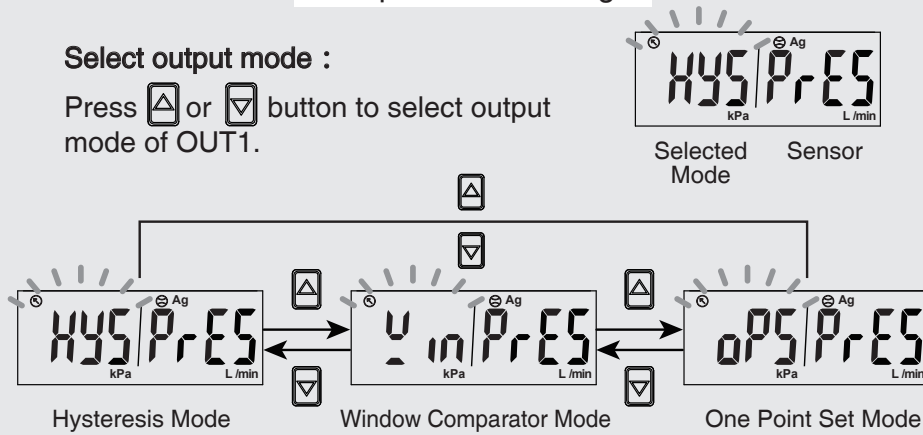



Press button ↓ (to be continued)



### Output Type Setting

#### OUT1 type setting :

Press  or  button to select OUT1 type.

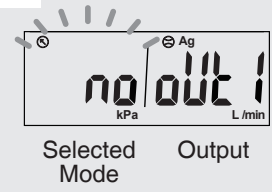
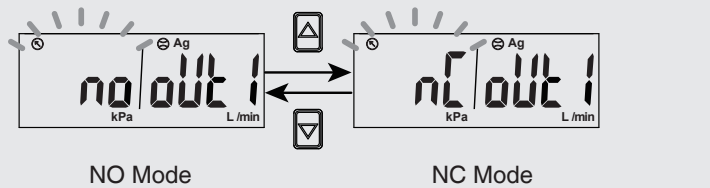

Press  button

### Set Value Setting

#### Out1 set value setting :

Press  or  button to adjust the set value.

Hysteresis Mode [HYS] : [L - ] · [H - ]

Window Comparator Mode [WIN] : [L - ] · [H - ]

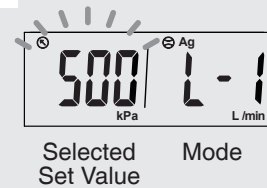

One Point Set Mode [OPS] : [P - ]



Press  button

### Fixed Hysteresis Setting

#### Fixed hysteresis setting :

Press  or  button to adjust fixed hysteresis value.

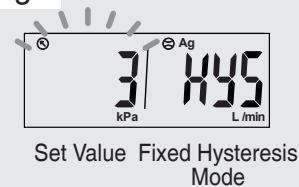

NOTE : Fixed hysteresis setting will not display when Hysteresis Mode is set.

Press  button to return to Function Selection Mode



### Normal Open Mode

#### Hysteresis Mode

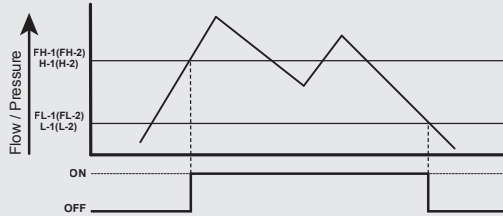

### Normal Close Mode

#### Hysteresis Mode

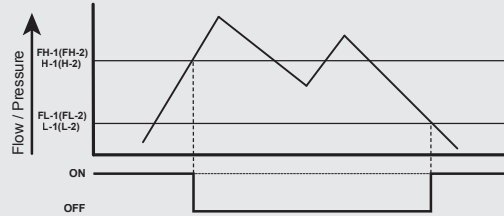

#### Window Comparator Mode

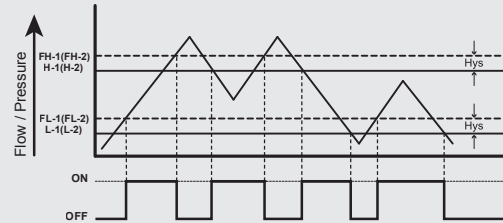

#### Window Comparator Mode

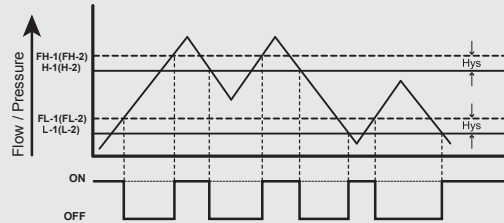

#### One Point Set Mode

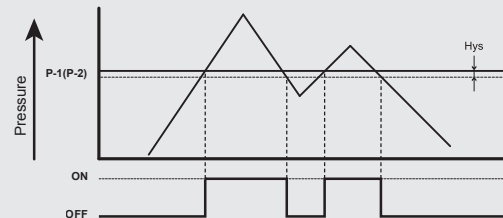

#### One Point Set Mode

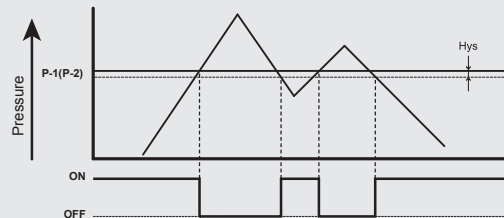

#### Accumulated Output Mode

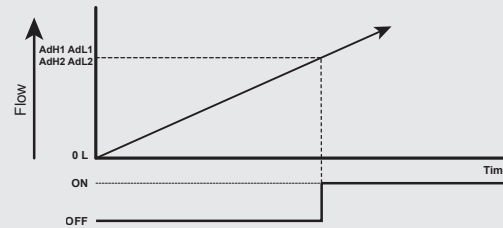

#### Accumulated Output Mode

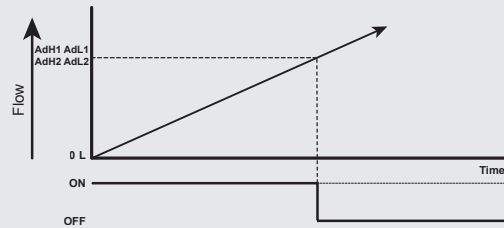

#### Accumulated Pulse Output Mode

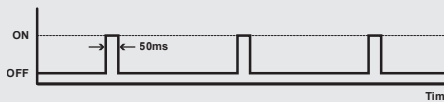



Flow Range	500mL	1000mL	5L	10L	50L	100L	200L
Pulse Output Rate	5mL	10mL	0.05L	0.1L	0.5L	1L	2L

**[NOTE:]**

- \*1. In case hysteresis is set at less than or equal to 2 digits, switch output may chatter if input pressure fluctuates near the set point.
- \*2. When using window comparator mode, the difference between two set points must be greater than the fixed hysteresis, otherwise will cause the switch output to malfunction.

### 2.3.2 [F-02] OUT2 Setting Selection

Setting corresponding sensor and operating mode of OUT2.

1. Press  or  button at function setting mode to start "OUT 2 Setting" [F-02] [OUT2].
2. Check the [F-01] for the same follow setting.

NOTE : The OUT2 Setting dose not have Accumulated Pulse Output Mode.

### 2.3.3 [F-03] LCD Display Color Selection

4 LCD Display Color Modes of output value selection.

< Operation >

Press or button at Function Selection Mode to display [F-03] [CLor].

Press button

#### Output Selection

Press the or button to select color display for OUT1 or OUT2.

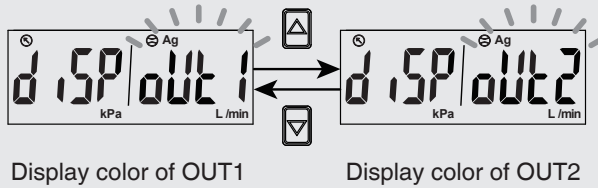
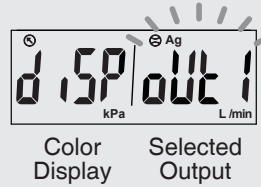

Press button

#### Display Color Mode Selection

Press the or button to select Display Color Mode.

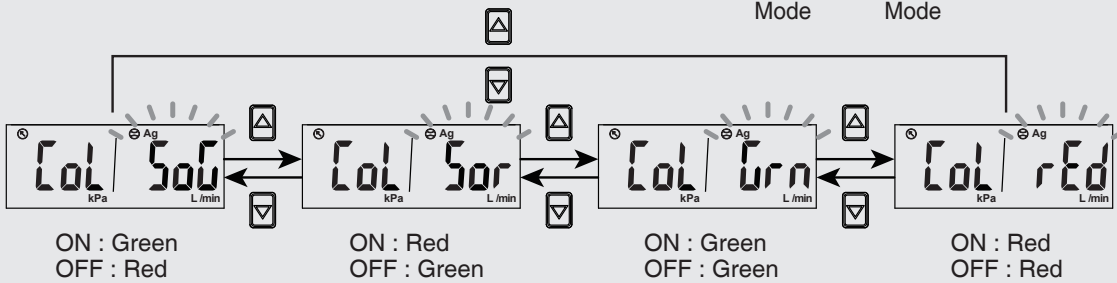
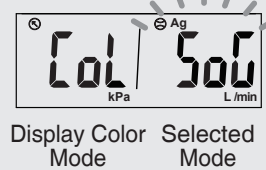



Press button to return to Function Selection Mode



### 2.3.4 [F-04] Response Time Selection



Select proper response time to avoid switch output chattering.

#### ● 1. Flow sensor setting

Press  or  button at Function Selection Mode to display [F-04] [rESP].

Press  button

#### Sensor Selection

Press  or  button to select the flow sensor.

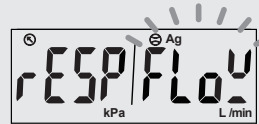

Response Time Selected Sensor

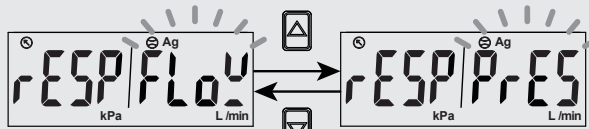



Flow sensor

Pressure sensor

Press  button

#### Response Time Selection

Setting response time of flow sensor :

Press  or  button to select response time.

7 Response time selections include:  
50ms, 80ms, 120ms, 200ms, 400ms, 800ms, 1500ms

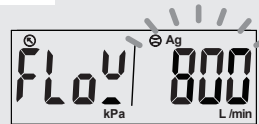

Selected Sensor Set Value

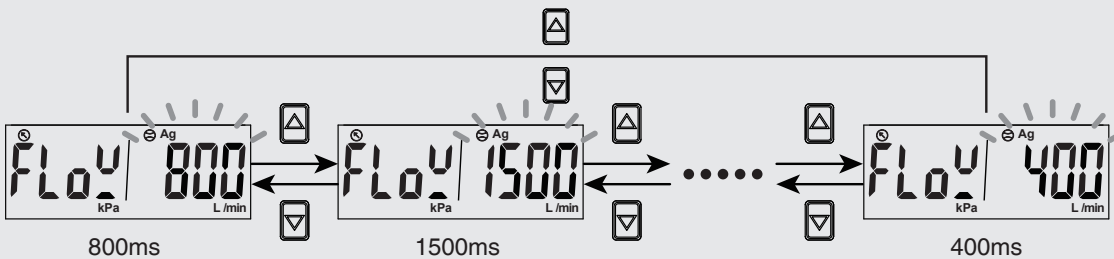

Press  button to return to Function Selection Mode



● 2. Pressure sensor setting

Press or button at Function Selection Mode to display [F-04] [rESP].

Press button

Sensor Selection

Press or button to select the pressure sensor.

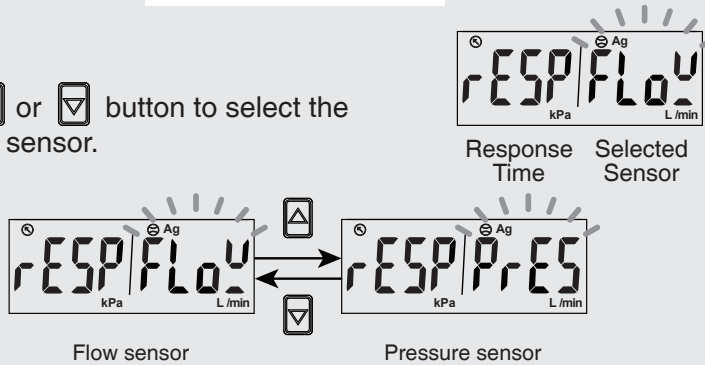

Press button

Response Time Selection

Setting response time of pressure sensor :

Press or button to select response time.

7 Response time selections include:  
2.5ms, 25ms, 100ms, 250ms, 500ms, 1000ms, 1500ms

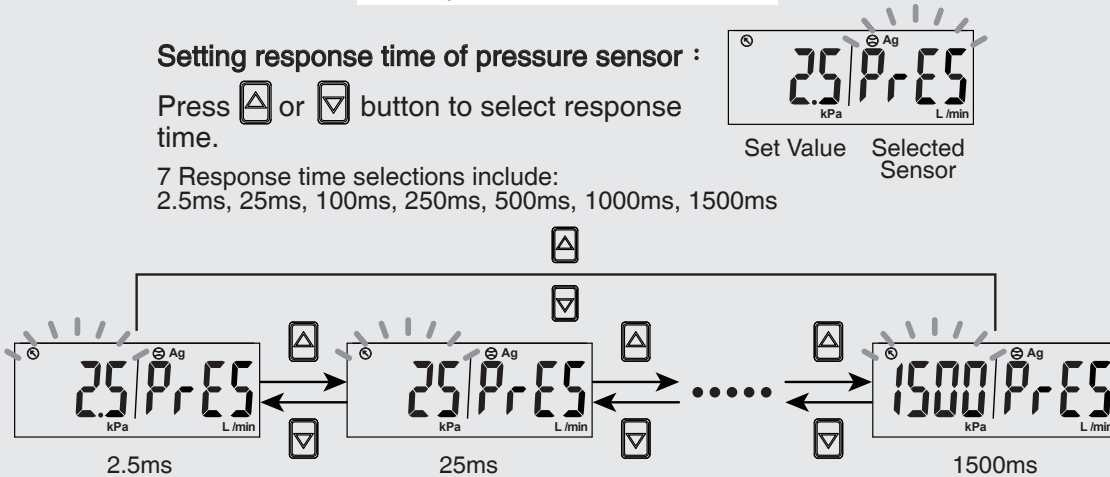



Press button to return to Function Selection Mode



### 2.3.5 [F-05] Display Refresh Time Selection

Select the proper display refresh time to reduce frequently changing value.

#### ● 1. Flow sensor setting

Press  or  button at Function Selection Mode to display [F-05] [UPdR].

Press  button

#### Sensor Selection

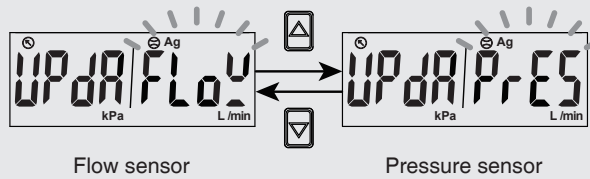

Press  or  button to select the flow sensor.



Press  button

#### Display Refresh Time Setting

**Setting refresh time of flow sensor :**

Press  or  button to select refresh time.

3 display refresh time selections include:  
200ms, 500ms, 1000ms

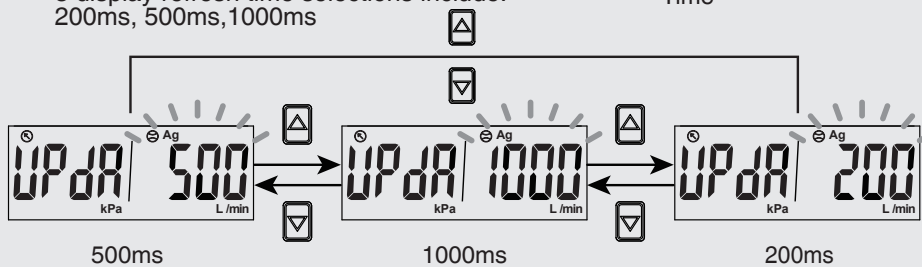
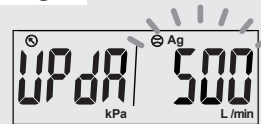

Press  button to return to Function Selection Mode



● 2. Setting display refresh time of pressure sensor

Press or button at Function Selection Mode to display [F-05] [UPdA].

Press button ↓

Sensor Selection

Press or button to select the pressure sensor.

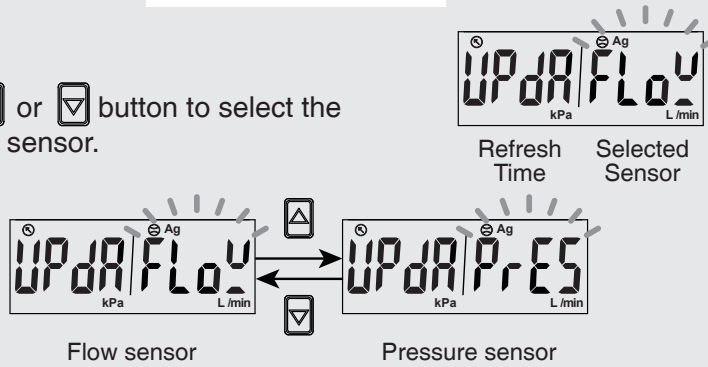

Press button ↓

Display Refresh Time Setting

Setting refresh time of pressure sensor :

Press or button to select refresh time.

3 display refresh time selections include:  
200ms, 500ms, 1000ms

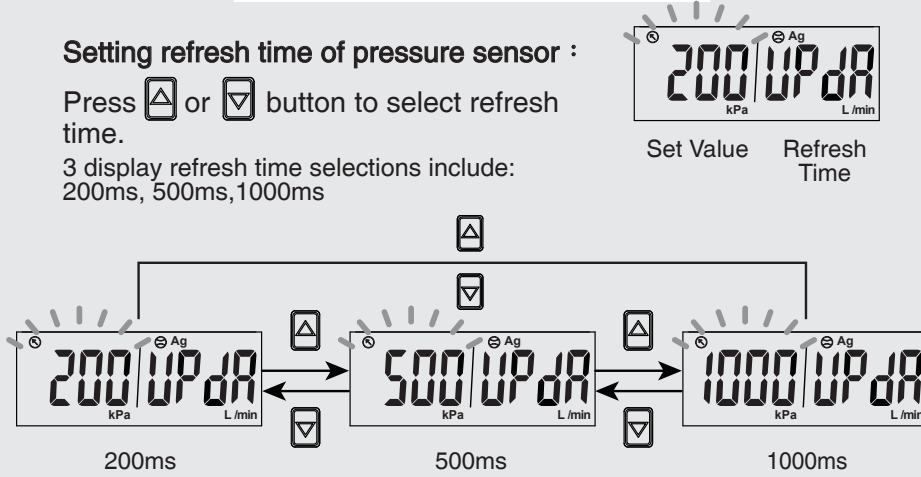

Press button to return to Function Selection Mode ↓







### 2.3.6 [F-06] Unit Selection

Select the flow unit and pressure unit of the sensor.

#### < Operation >

Press  or  button at Function Selection Mode to display [F-06] [Unit] °

Press  button ↓

#### Flow Unit Selection

Press  or  button to select flow unit.

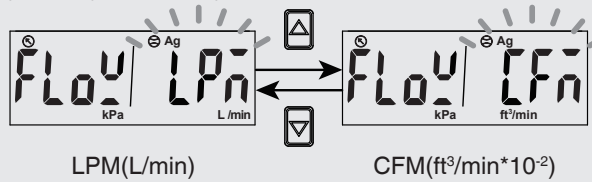
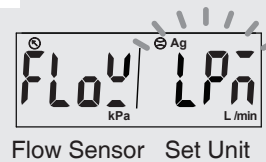

2 flow unit selections include:  
LPM(L/min), CFM(ft<sup>3</sup>/min\*10<sup>-2</sup>)



※ NOTE : When the measured flow rate range is 500mL/min or 1000mL/min, the unit of LPM is selected to represent the unit in mL/min.

Press  button ↓

#### Pressure Unit Selection

Press  or  button to select pressure unit.

4 pressure unit selections include:  
kPa, kgf/cm<sup>2</sup>, bar, psi

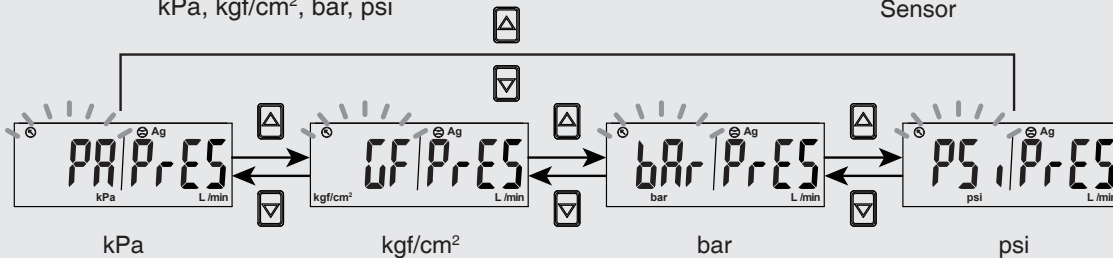
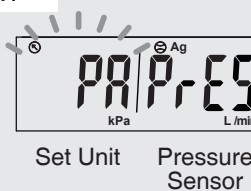

Press  button to return to Function Selection Mode ↓



### 2.3.7 [F-07] Flow Reference Standard Selection



Select the flow value is shown under standard or normal condition.

#### < Operation >

Press  or  button at Function Selection Mode to display [F-07] [rEFE] °

Press  button

#### Flow Reference Standard Selection

Press  or  button to select the standard or normal condition.

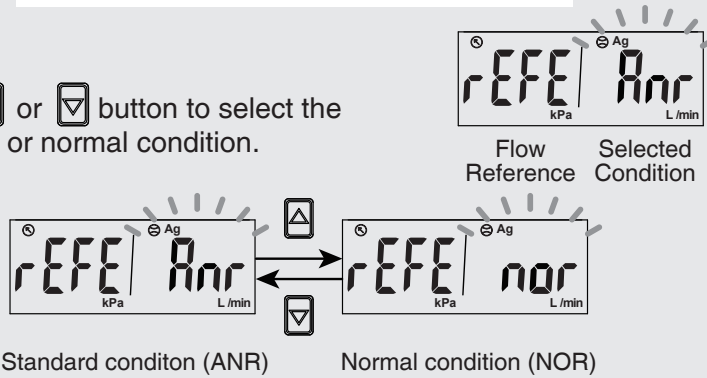

※NOTE :

1. Standard condition (ANR): the display value is calculated under 20°C, 1atm.
2. Normal condition (NOR): the display value is calculated under 0°C, 1atm.
3. Flow rate in the specification is the value at standard condition (ANR).



Press  button to return to Function Selection Mode



### 2.3.8 [F-08] Analog Output Selection

Select the analog output signal is for flow sensor or pressure sensor.

#### < Operation >

Press  or  button at Function Selection Mode to display [F-08] [AnC] °

Press  button

#### Sensor Selection

Press  or  button to select the sensor of analog output.

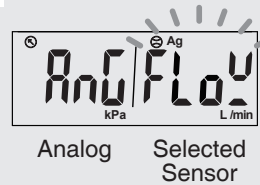
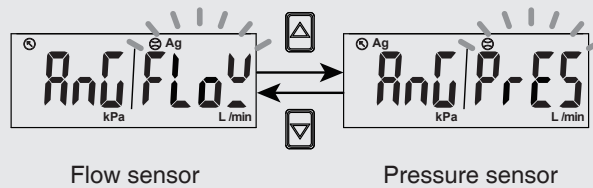

※NOTE : Output specification 02 and 04 have no this function.

Press  button to return to Function Selection Mode

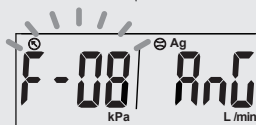

### 2.3.9 [F-09] Accumulated Value Hold Selection

The default setting is "OFF", the accumulated flow value is zeroed when the power supply is turned off.

Select this function to keep accumulated flow value to be stored in permanent memory and reload the recent saved accumulated value after power supply turns on.

#### < Operation >

Press or button at Function Selection Mode to display [F-09] [EEP\_r] ◦

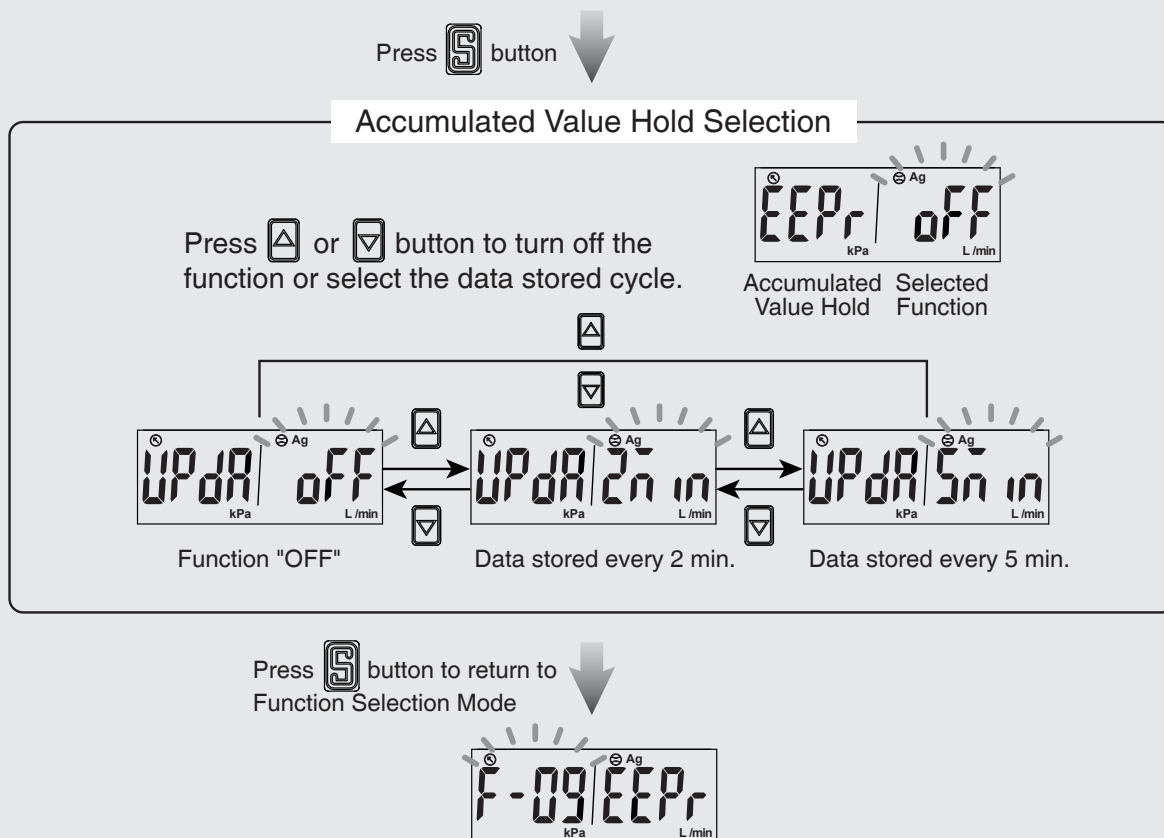

#### ※ NOTE :



The maximum writable limit of the memory device is 1 million cycles. If the sensor is operated 24 hours per day, the durability is calculated as below:

- ◆ 5 minutes x 1 million cycles = 5 million minutes = 9.5 years
- ◆ 2 minutes x 1 million cycles = 2 million minutes = 3.8 years

### 2.3.10 [F - 10] Flow Sensor Display Mode Selection



Select to display Instantaneous Flow or Accumulated Flow Mode.

#### < Operation >

Press  or  button at Function Selection Mode to display [F - 10] [d ,5] °



Press  button 

#### Display Mode Selection

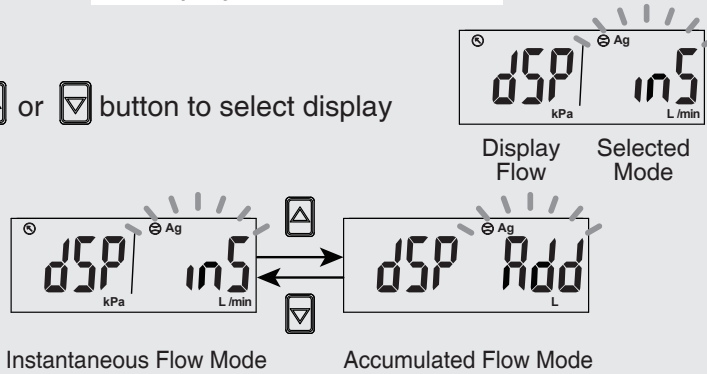
Press  or  button to select display mode.



※NOTE : When the measured flow rate range is 500mL/min or 1000mL/min, the accumulated flow is selected and the unit will become in mL/min.

Press  button to return to Function Selection Mode 

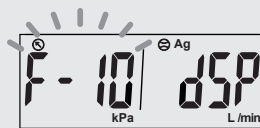



### 2.3.11 [F-9 1] Power-Save Mode Selection

Select Power-Save Mode at Measurement Mode.



During the Power-Save Mode, the main display will be turned off if no buttons are pressed in 30 sec., press any keys to leave the Power-Save Mode.

#### < Operation >

Press  or  button at Function Selection Mode to display [F-9 1] [ECo] .

Press  button

#### Power-Save Mode Selection

Press  or  button to turn on the power-save mode.

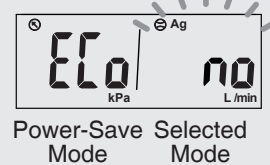
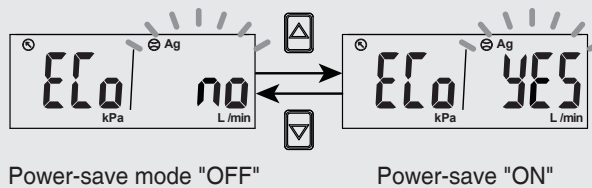

※NOTE : During the Power-Save Mode, the decimal point will flash.

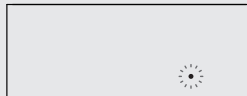

Press  button to return to Function Selection Mode



## 2.3.12 [F-92] External Input Selection



Accumulated flow external reset : The accumulated flow value will reset to "0" when an external input signal is applied.

Auto-shift : The instantaneous flow rate will regard as the standard when the external input signal is applied. The switch output function operates relative to its change.

Auto-shift zero : The instantaneous flow rate is reset to zero to regard as standard when the external input signal is applied. The switch output function operates relative to its change.



This function is only for output 1 corresponding to flow sensor action point. When external signal is input, please connect the input wire to GND for 30 ms or more.

### < Operation >

Press  or  button at Function Selection Mode to display [F-92] [inp] °.

Press  button

### External Input Selection

Press  or  button to select external input function.

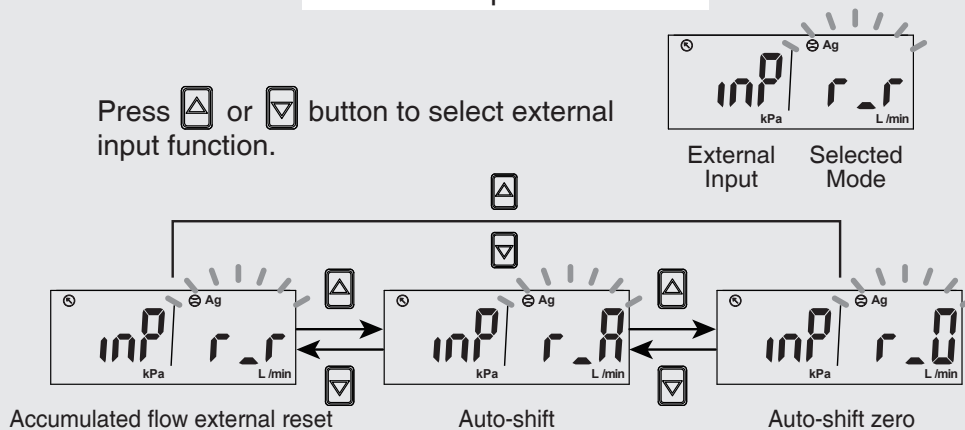

#### ※NOTE :

1. Output specification 02 and 04 have no this function.
2. When external signal is input, the instantaneous flow rate value will be shown "0000".

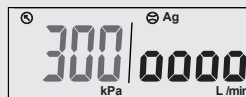

Press  button to return to Function Selection Mode

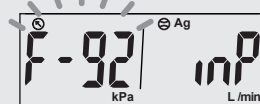

### 2.3.13 [F-94] Fine Adjustment Setting

This function is to fine adjust flow and pressure display values.  
 Display values can be calibrated to within  $\pm 2.5\%$  R.D.

- 1. Fine adjustment of instantaneous flow value

Press or button at Function Selection Mode to display [F-94] [F inE] .

Press button ↓

#### Fine Adjustment Setting

Press or button to select fine adjustment OFF or to set fine adjustment instantaneous flow rate value or pressure value.

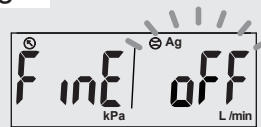

Fine Adjustment Set Value

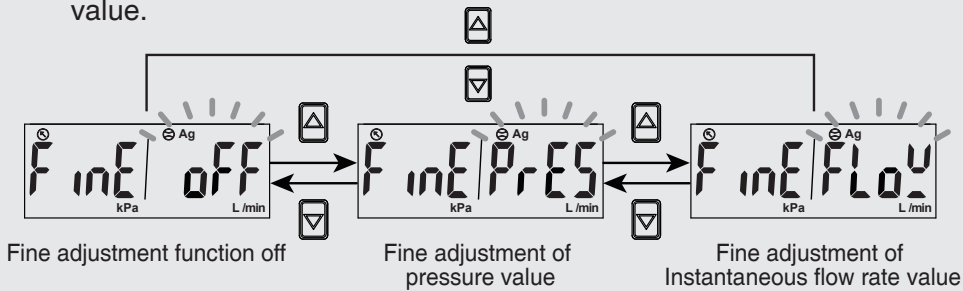

#### Fine Adjustment of Instantaneous Flow Rate Value

**Fine adjustment of instantaneous flow rate value :**

Press or button to set fine adjustment value.

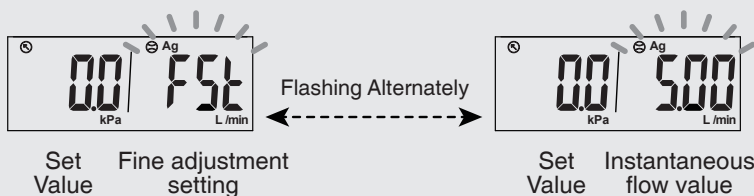



※NOTE : Display will flashing between instantaneous flow value and "FST".

Press button ↓

Return to the measurement mode





● 2. Fine adjustment of pressure value

Press  or  button at Function Selection Mode to display [F-94] [F inE] °

Press  button ↓

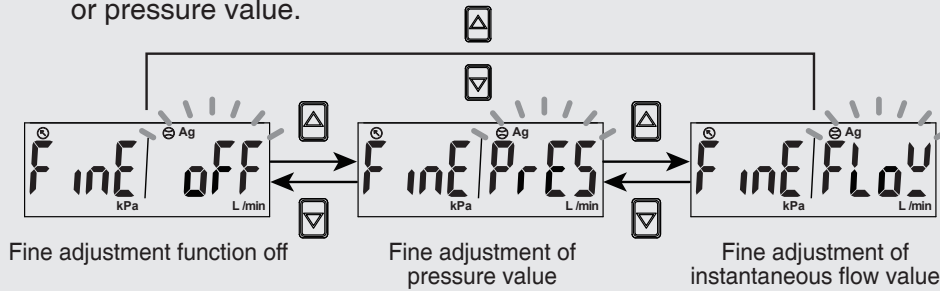
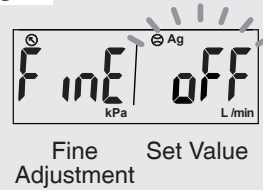

Fine Adjustment Setting

Press  or  button to select fine adjustment function off or select fine adjustment of instantaneous flow value or pressure value.



Fine Adjustment of Pressure Value

**Fine adjustment of pressure value :**

Press  or  button to setting fine adjustment of display value.

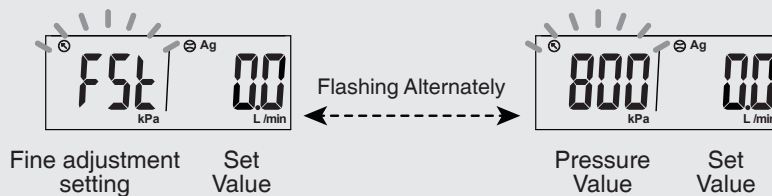

※NOTE : Display will flashing between pressure value and "FST".

Press  button ↓

Return to the measurement mode

### 2.3.14 [F-95] Forced Output Function



To turn the analog ON/OFF forcibly.

#### < Operation >

Press  or  button at Function Selection Mode to display [F-95] [FOUT] .

Press  button

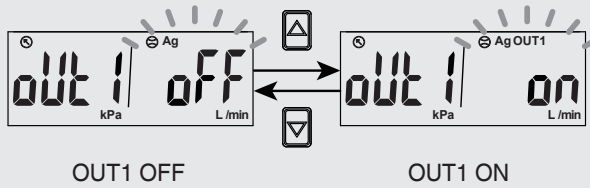
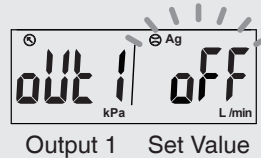

#### OUT1 setting

Press  or  button to setting OUT1.



Press  button

#### OUT2 setting

Press  or  button to setting OUT2.

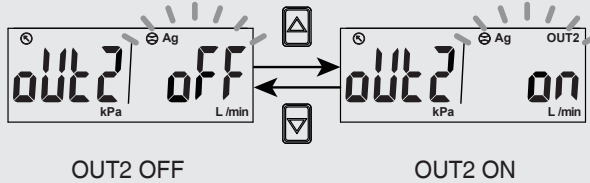
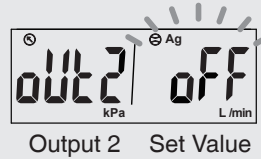

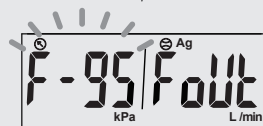

Press  button to return to Function Selection Mode



### 2.3.15 [F-99] Reset to the Default Setting



The factory default settings can be restored.

#### < Operation >

Press  or  button at Function Selection Mode to display [F-99] [rESt] .

Press  button

#### Reset to The Default Setting

Press  or  button to return to the factory default setting.

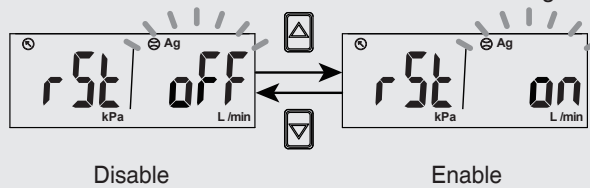



Press  button to return to Function Selection Mode



## 2.3.16 Pressure Zero Adjustment Function

The displayed value can be adjusted to "0" when the pressure is within  $\pm 3\%$  of the zero point at the time of shipment from the factory.

### < Operation >

Press  and  button simultaneously over 3 sec. at the measurement mode (not Accumulated flow value display mode) until display [00]. And release holding the button to return measurement mode.

Measurement mode

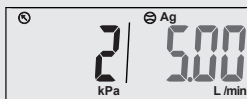

Press  and  button simultaneously over 3 sec.

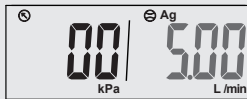

To release holding the button to return measurement mode.

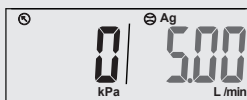



Pressure value return zero.

### 2.3.17 Instantaneous Flow Zero Adjustment Function

The displayed value can be adjusted to "0" when the measured flow is within  $\pm 10\%$  F.S. of the zero point at the time of shipment from the factory.

#### < Operation >

Press  and  button simultaneously over 3 sec. at the measurement mode (not Accumulated flow value display mode) until display [00]. And release holding the button to return measurement mode.

Measurement mode

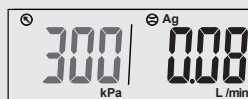

Press  and  button simultaneously over 3 sec.

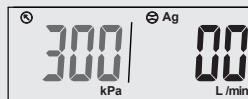

To release holding the button to return measurement mode.





Instantaneous flow value return zero.

## 2.3.18 Reset Accumulated Flow Function

Accumulate flow value return to zero.

### < Operation >

Press  and  button simultaneously over 3 sec. at the measurement mode (Accumulated flow value mode) until display zero.

And release holding the button to return measurement mode.

Measurement mode



Press  and  button simultaneously over 3 sec.





Accumulated value display zero.  
To release holding the button to return measurement mode.

### 2.3.19 Peak Value Display

The maximum pressure and instantaneous flow, from when the power was supplied to this moment, is detected and updated.

#### < Operation >

Press  button over 3 sec. at the measurement mode. The maximum value will be displayed flashing, and is held.

Press  button return to the measurement mode.

Measurement mode

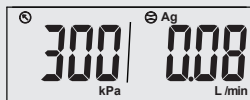

Press  button over 3 sec.

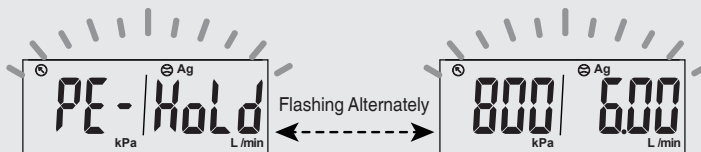

Press  button return measurement mode.

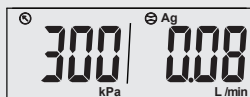

## 2.3.20 Bottom Value Display

The minimum pressure and instantaneous flow, from when the power was supplied to this moment, is detected and updated.

### < Operation >

Press  button over 3 sec. at the measurement mode. The minimum value will be displayed flashing, and is held.

Press  button return to the measurement mode.

Measurement mode

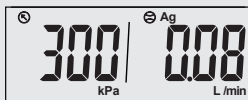

Press  button over 3 sec.

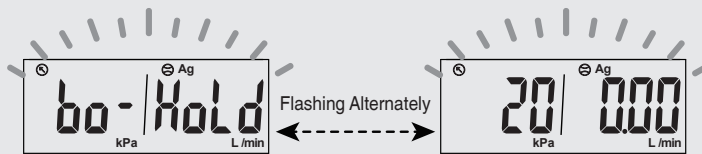

Press  button return measurement mode.

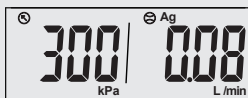





### 2.3.21 Key Lock / Unlock Mode

To prevent errors occurring due to unintentional changes of the set values. If a button operation is performed while the key lock setting is ON, [LoL] [on] is displayed for 1 sec.

#### < Operation >

Press  button over 5 sec. at measurement mode to select key lock/unlock setting.

#### Key Lock / Unlock Setting

Press  or  button to select locking or unlocking of the key.

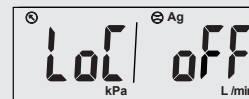

Default Setting

Selected Mode

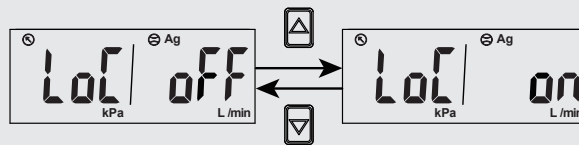

Unlock

Lock

※NOTE : If a button operation is performed while the key lock setting is ON, [LoL][on] will displayed.



Displayed for 1 sec.

### 3. ERROR CODE INSTRUCTION

Error Type	Error Code	Error Condition	Troubleshooting
OUT1 Excess Load Current Error		Output 1 load current is more than 125 mA	Turn power off and check the cause of overload current or lower the current load under 125 mA, then restart.
OUT2 Excess Load Current Error		Output 2 load current is more than 125 mA	
Zero Adjustment Error		The instant flow is within $\pm 10\%$ F.S. of the zero point.	Perform the zero clear function again under no flow conditions.
		The pressure value is over $\pm 3\%$ F.S. of the zero point.	Perform the zero clear function again under no pressure conditions.
System Error		Memory error	Turn power off, and then restart. If error condition remains, please return to factory for inspection.
		Internal data error	
		Internal data error	
		System parameter error	
Applied Flow/Pressure Error		The instant flow has exceeded the upper limit of the flow display range.	Reduce the flow to the display range.
		The pressure has exceeded the upper limit of the pressure display range.	Reduce the pressure to the display range.
		The instant flow has exceeded the lower limit of the flow display range.	Ensure the flow is in the correct direction.
		The pressure has exceeded the lower limit of the pressure display range.	Reduce the pressure to the display range.

#### 4. TECHNICAL DATA

		FLUX 0 50 L	FLUX 0 200 L
Measured flow range	Nl/min	0 - 50	0 - 200
Direction of flow		Unidirectional	
Working pressure range	bar	-0.9 to 8	
	MPa	-0.09 to 0.8	
	psi	-13 to 116	
Maximum admissible pressure	bar	10	
Pipe diameter for push-in fitting	mm	8	
Connecting cable	VDC	12 to 24 ± 10%, ripple max 10%	
Current consumption	mA	≤ 50	
Power cable		Cable Ø 4 length 2 m, oil resistant, 26 AWG (6 x 0.15 mm <sup>2</sup> )	
Weight	g	100 (including cable)	
<b>DISPLAY</b>			
Instant flow rate			
Display range	Nl/min	0 - 50	0 - 200
Minimum setting scale	Nl/min	0.1	1
	ft <sup>3</sup> /min	1	1
Cumulative flow rate			
Display range		9999999.9	99999999
Minimum setting scale	Nl	0.1	1
	ft <sup>3</sup>	1	1
Pressure			
Display range	kPa	-100 to 1000	
Minimum setting scale	kPa	1	
	bar	0.01	
	psi	0.1	
<b>PRECISION</b>			
Flow rate			
Guaranteed measuring range		2 to 100 % FS	
Display accuracy		± 3 % FS ± 1 digit ▲	
Analogue output accuracy		± 5 % FS ▲	
Repeatability		± 1 % FS ± 1 digit ■	
Linearity		± 3 % FS ■	
Temperature characteristic		± 2 % FS for a temperature range of 15-35°C; ± 5 % FS for a temperature range of 0-15°C or 35-50°C ■	
Pressure characteristic		± 5 % FS ± 1 digit *	
Pressure			
Guaranteed measuring range		0 to 100 % FS	
Display accuracy		± 2 % FS ± 1 digit ●	
Analogue output accuracy		± 2.5 % FS ●	
Repeatability		± 0.2 % FS ± 1 digit ●	
Linearity		± 1 % FS ●	
Temperature characteristic		± 2 % FS ●	
<b>DIGITAL OUTPUTS</b>			
N ° outputs		2 PNP	
Max current	mA	125	
Max voltage	VDC	24	
Residual voltage	V	≤ 1.5 V	
Response time, with flow rate setting	ms	50, 80, 120, 200, 400, 800, 1500 (default 800)	
Response time, with pressure setting	ms	2.5, 25, 100, 250, 500, 1000, 1500 (default 2.5)	
Response mode, with flow rate setting		Hysteresis mode, window comparison mode, cumulative mode, cumulative pulse mode Normally open or normally closed	
Response mode, with pressure mode setting		One-point setting mode, hysteresis mode, window comparison mode. Normally open or normally closed	
Hysteresis		Adjustable	
Short-circuit protection at output		Yes	
Cumulative pulse output	Nl/impulse	0.5	2
	ft <sup>3</sup> /impulse	2	7

▲ Data valid under these conditions: input pressure 3 bar, output pressure 1 bar, temperature 25°C

■ Data valid under these conditions: output pressure 1 bar, temperature 25°C

\* Data valid under these conditions: -90 to 800 kPa, output pressure 1 bar, temperature 25°C

● Data valid under these conditions: flow rate 0 Nl/min, temperature 25°C



		FLUX 0 50 L	FLUX 0 200 L
<b>ANALOGUE OUTPUT</b>			
Version with voltage	V		1 to 5, 1 k $\Omega$ impedance
Version with current	mA		4 to 20, with $\leq 300 \Omega$ impedance
Response time, with flow rate setting	ms		$\leq 100$
Response time, with pressure setting	ms		$\leq 50$
<b>AMBIENT CONDITIONS</b>			
Fluid		Filtered and unlubricated air, inert non-corrosive and non-explosive gas. A 5 $\mu\text{m}$ filter and a 0.01 $\mu\text{m}$ oil purifier are recommended	
Degree of protection		IP 40	
Temperature range	$^{\circ}\text{C}$	0 to 50	
Storage temperature	$^{\circ}\text{C}$	0 to 60, but without condensate or ice	
Ambient humidity		35 to 85% relative humidity; no condensate	
Insulation voltage		1000 VAC for one minute between casing and cable	
Resistance of Insulation		Min. 50 M $\Omega$ (at 500VDC between casing and cable)	
Vibration admitted		1.5 mm amplitude or 10 g with scanning every minute from 10 to 55 Hz at 10 Hz, for 2 hours in each direction x, y and z	
Impact		100 m/s <sup>2</sup> (10 g), 3 times in each direction x, y and z	
Electromagnetic compatibility (EMC)		IEC 61000-6-2, IEC 61000-6-4	



## 5. THERMAL MASS FLOW SENSOR PRINCIPLES

**Symmetric  
Temperature Profile  
No Flow**

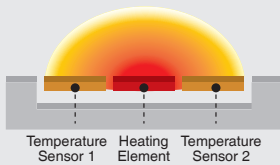

(a) : No Flow

In the absence of flow, the heat of the heater spreads evenly left and right, so the temperature distribution is like (a).

**Skewed  
Temperature Profile  
Small Flow**

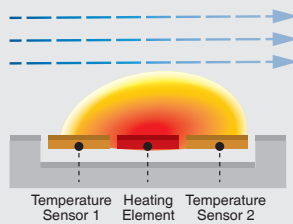

(b) : Small Flow

When there is a flow, the inlet side is cooled by the flow, the outlet side is warmed by the heat of the inlet side of the heater, and the temperature distribution is like (b).

**Skewed  
Temperature Profile  
Large Flow**

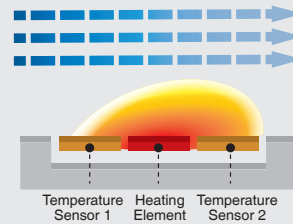

(c) : Large Flow

When the flow becomes large, it becomes a distribution like (C). Since the temperature distribution before and after the heater is proportional to the flow rate, the flow rate can be determined from the ratio.

## 6. DIMENSIONS

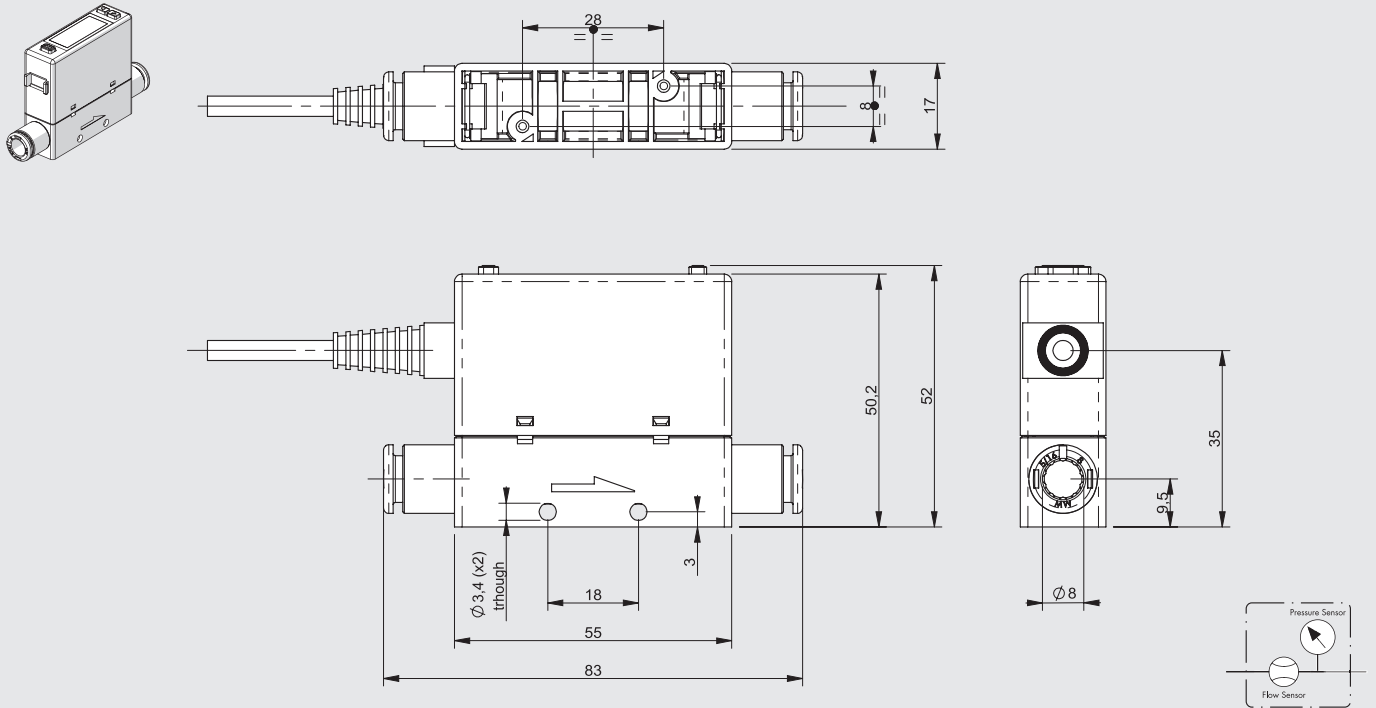

## 7. CONSTRUCTION

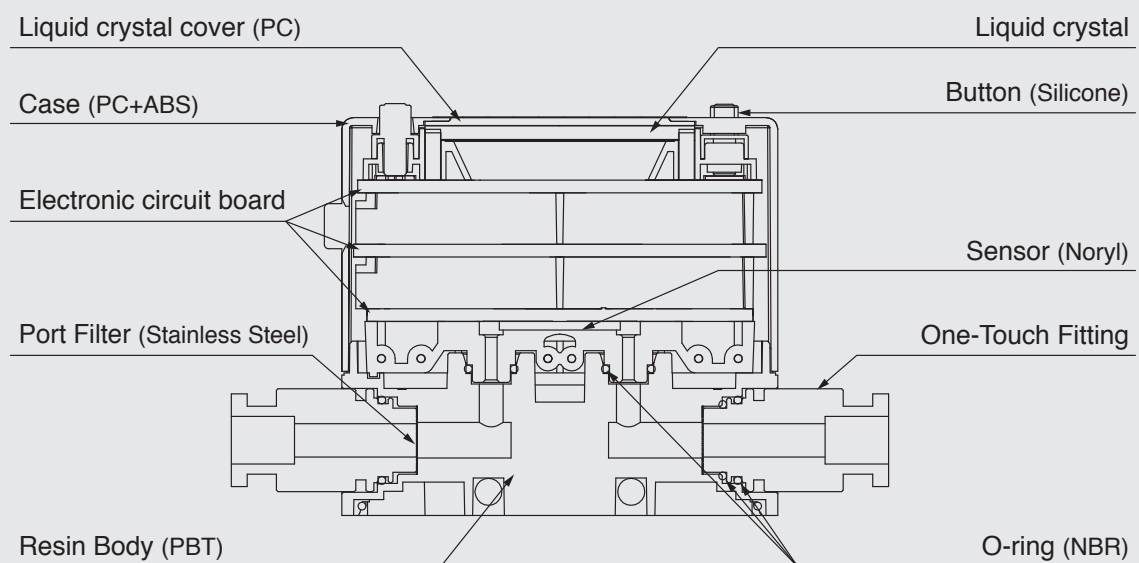

NOTES

Lined area for notes.

